

Φ 160

179

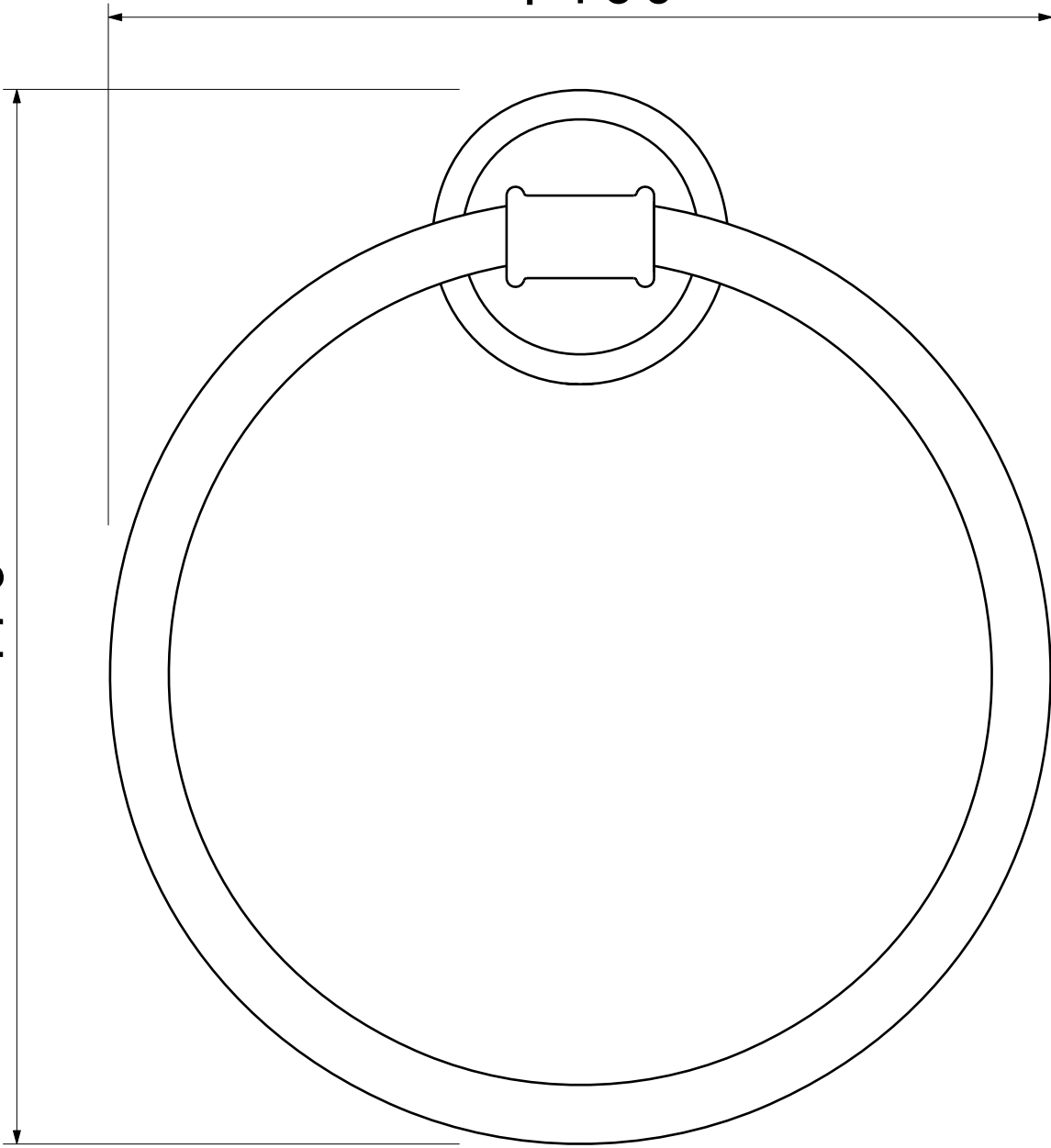

65

