

INSTALLATION INSTRUCTIONS

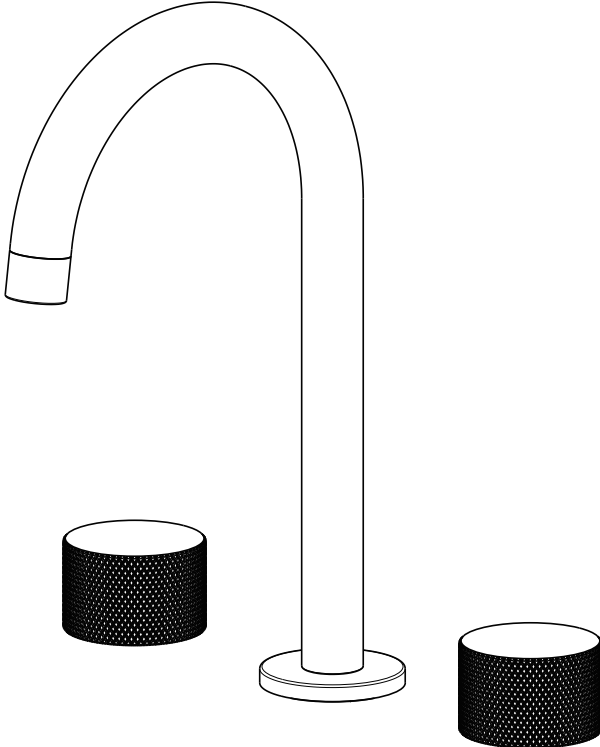

Before Installation

- We recommend that this product is installed by a qualified professional plumber / contractor.
- Please check this product immediately to ensure that it has not been damaged and is complete. Before installation, please make sure this product is the correct model and you have all the parts required for installation and using.
- Please flush the water system to ensure that no metal swarf, solder, and other impurities can enter the taps.
- Turn off water supply before commencing work, this should be done at the isolating valves of inlet feeds if fitted or main stopcock.
- Please read these instructions carefully and keep it for future reference.

Tools you may need

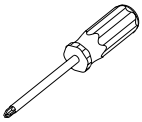

Phillips screwdriver



Adjustable wrench

x2



Bucket

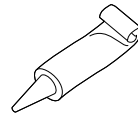

Silicone sealant

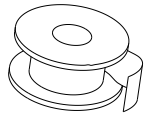

Pipe tape

1

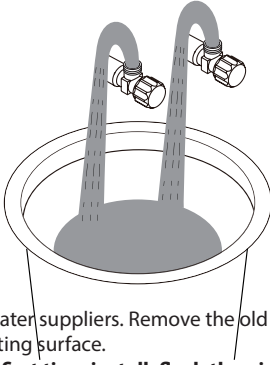

Shut off water suppliers. Remove the old faucet, clean the mounting surface.

Note: For first time install, flush the pipes first by open the angle valve to run 60s.

2

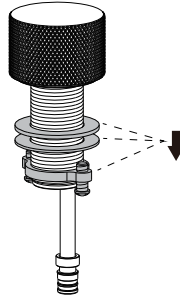

Remove the mounting hardware from the mounting pipe.

3

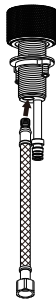

Connect the water supply lines to faucet.

4

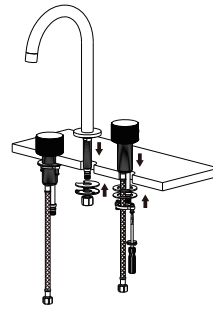

From below the sink, Slide rubber washer, metal washer and mounting bracket onto the thread shank, Then tighten the mounting nuts with phillips screwdriver until snug.

5

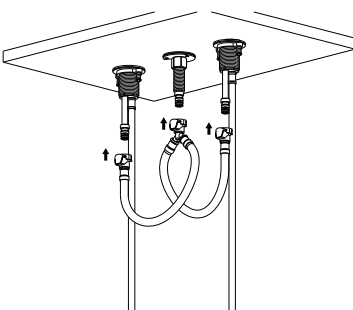

Position the flexible hose as shown and fix it to the faucet.

6

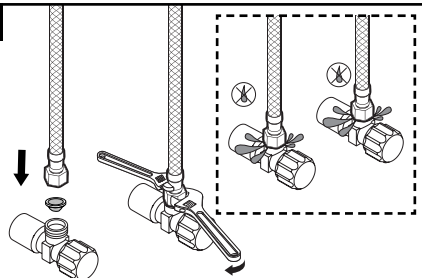

Connect and tighten the supply hoses by using two adjustable wrenches (avoid twisting or kinking). Turn on the angle valve and check for leaks.

Note: Do not remove the net filter that attached into the connecting end!

Dimension

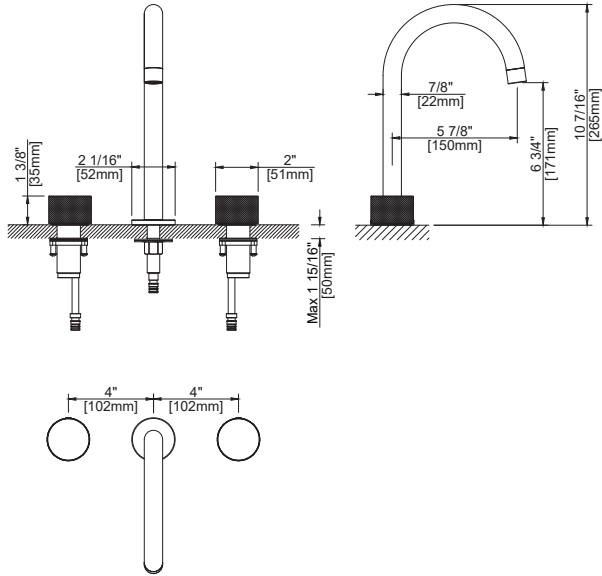

Cleaning and care

Our Kitchen and bathroom products are made of solid brass to comply with the needs of the market with regard to design and functionality. To avoid damage to the product, it is necessary to take proper care of it.

Clean the faucet often with a soft cloth to keep it looking like new. For heavy cleaning you can use mild liquid detergents or non-abrasive liquid polisher. Rinse with water and dry with a soft cloth. Avoid abrasive cleaners, steel wool and harsh chemicals as these will dull the finish and void your warranty.