

# Installation Guide

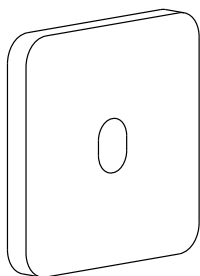
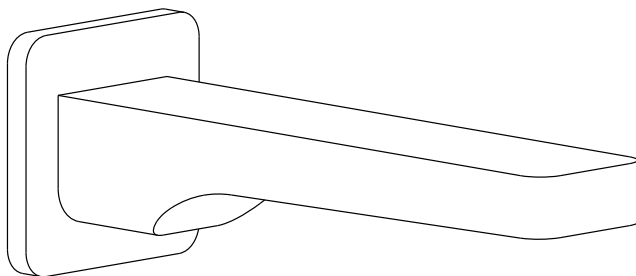

# Installation Instructions

 **READ ALL INSTRUCTIONS BEFORE UNPACKING THE PRODUCT** 

## Product features

### 1- Convenient:

Water starts flowing automatically when the hands are placed within the sensing range. When the hands are moved out of the sensing range, the water will stop flowing immediately.

### 2- Outstanding water saving effects:

There will be no wasting of water as the water flows only when the users put the hands under the faucet with low flow rate of 8.5L/min.

## Specifications

Activation	Activated by an infrared sensor. This product will start and stop operating automatically with maximum flow duration of 60 seconds.
Suitable pressure	Maximum: 0.05-0.8MPa(0.5-8.0 Bar ) Recommend: 0.1-0.4MPa(1.0-4.0 Bar )
Sensing range	5-30cm
Power supply	4×1. 5V AA size Alkaline battery (DC Model) 100V-240V, 50/60Hz (AC Model)
Battery durability	Approx. 109500 cycles (1.5 yrs@200 uses/day)
Flow rate	6L/min
Water temperature	1-45°C
Size of inlet	G1/2

## Important

- 1- Don't install this product in areas affected by strong magnetic.
- 2- Forbidden force or severe vibration. Avoid exposure to direct sunlight.
- 3- Never use benzene, thinner or acid detergent. Clean it with neutral detergent and soft cloth only.
- 4- If the sensor is stained with soap water or other impurities, the product may malfunction.
- 5- If the indicating light flashes continually, it means the battery voltage is not enough, please replace the battery immediately.
- 6- Clean the filter regularly to prevent water pipe blockage and caused water flow smaller.

# Connection

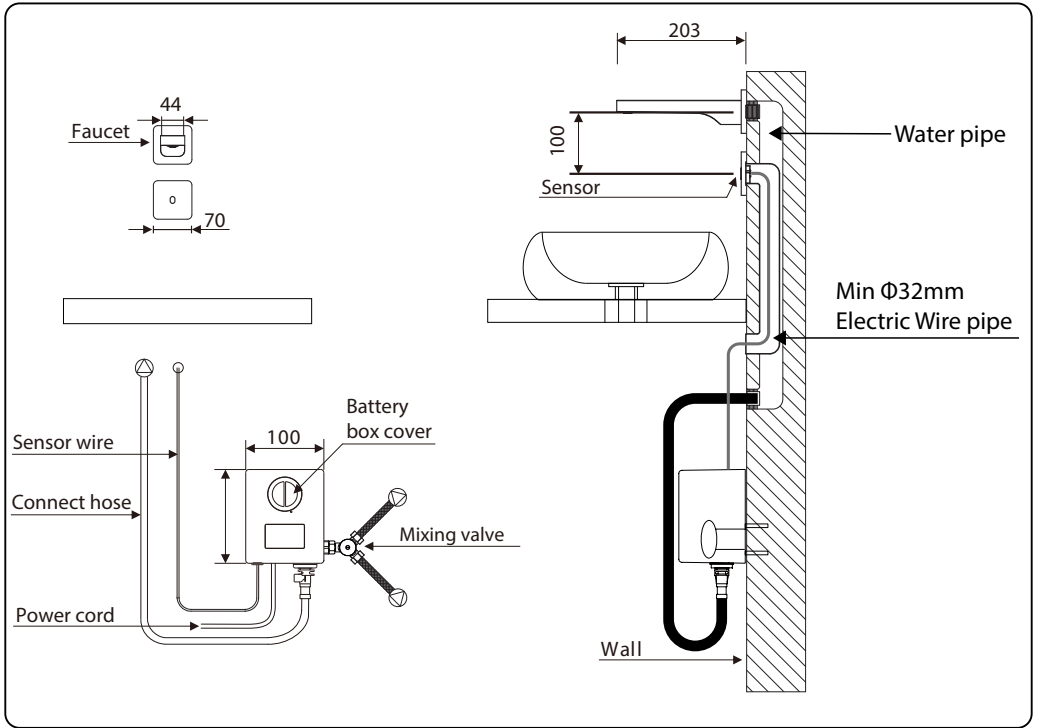

## Suggested Pre-buried Electric Wire Pipe and water pipe :

**Electric Pipe:** Suggested to using pipes diameter between 32-40mm, make sure wire mounting hole is at least 100mm higher than basin to avoid sensor window blocked, align the wire mounting hole to be centered with basindrain.

**Water Pipe:** Align the water pipe with the electric pipe, make sure the water pipe is at least 100mm higher than the wire pipe, leave G1/2 inlet connector to connect angel valve and solenoid valve, and G1/2 outlet connector to the faucet spout.

**Note! The angel valve is not provided and need prepare separately.**

# 1. Install Faucet

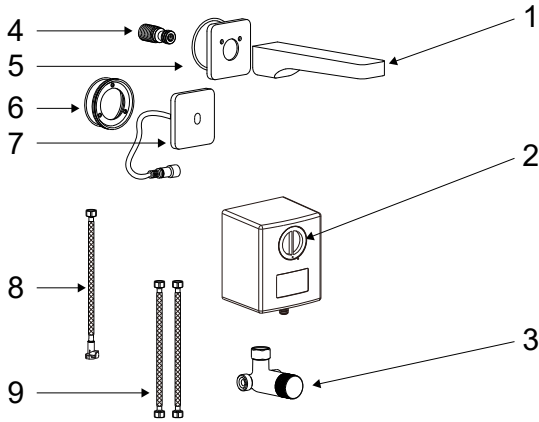

NO.	Part Name
1	Spout
2	Control box
3	Mixer valve
4	Connect
5	Trim plate
6	Mounting plate
7	Sensor Assembly
8	Connect hose
9	Water line

1. Position the mounting plate(6) and verify plumb. Mark the positions of the screw holes. Drill 6mm holes.
2. Insert ceramic anchors. Keep O-ring on mounting plate(6) then secure the mounting plate.
3. Thread the sensor assembly(7) through the electric pipe and take out from below the sink. then slide the sensor trim plate(7) onto the mounting plate(6). Tighten the setscrew.
4. Apply teflon tape onto male threads of connect(4). Screw connect(4) into the threaded adapter.
5. Keep O-ring on trim plate(5) then install the spout.

## 2. Install Control unit

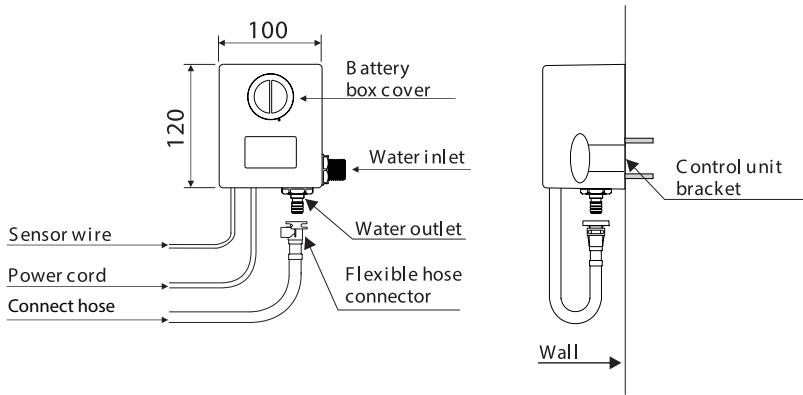

1. Drain water for one minute to remove all the foreign substances from the interior of the water pipe.
2. Close the water supply valve(s).
3. Put the control housing bracket on the wall ,use a pencil to draw two positioning holes, then use the impact drill to drill two mounting holes,and push the expansive plastic into the mounting holes, locking the control housing bracket on the wall with the M4×25mm screws.
4. insert the control housing into the bracket.

## 3. Connect flexible hose and wires

1. Connect the electronic wire to the electronic connector of the control housing.
2. Connect the connect hose connector to the outlet of control housing.
3. Connect the water supply to the inlet of the control housing.
4. In two minutes, according to the environment, the system will automatically adjust sensing distance, please don't put any objects in front of the sensor.

## 4. Change of battery for DC model

1. Open the battery & valve housing and take out the battery box.
2. Replace the old batteries with 4×AA new Alkaline batteries, then replace the battery box. (Note: Take note of the correct battery polarity.)

### Battery Replacement Steps:

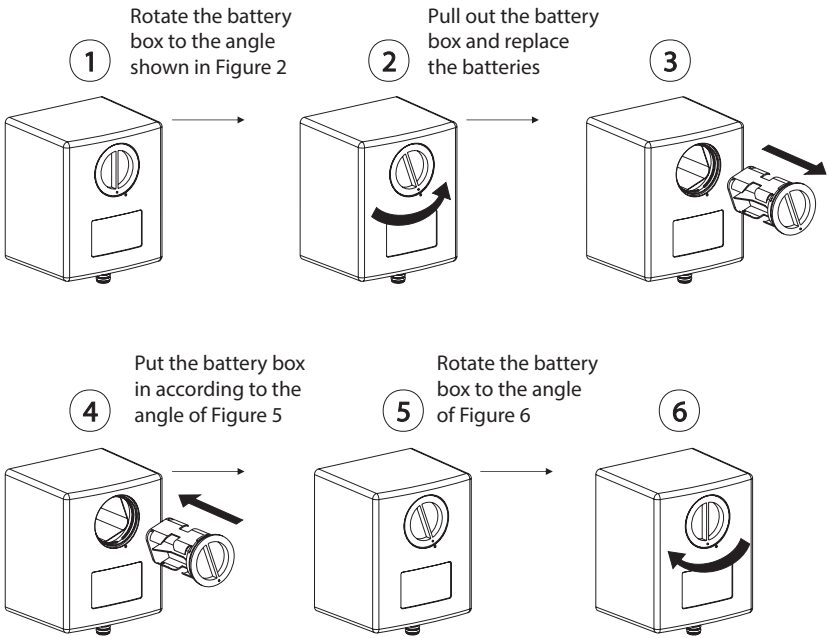



# Trouble Shooting

When the following faults occur in the product, it may not be caused by the failure of the product itself. Before contacting the after-sales service, please refer to the following table for inspection and elimination.

<b>Problem</b>	<b>Cause</b>	<b>Action</b>
Water does not flow when hands are placed within the sensing range	Suspension of power supply	Ensure the battery connector is properly connected and the battery wire is not damaged.
	The water supply valve is closed	Ensure that the stop valve is open.
	The battery has expired (Below 4.3V)	Change the battery.
Water flow rate is too small	The water supply valve is opened slightly	Fully open the water supply valve.
	Water pressure is too small	Check whether water pressure of other pipeline is the same.
	The flexible hose is poorly connected	Check whether the hose is bent or folded
	The filter or aerator is dirty	Remove the filter or aerator and clean it.
Water flow non stop	The sensor eye is stained with a foreign object	Clean the surface of the sensor with neutral detergent.
	The battery has expired (Blow 4.3V)	Change the battery. Use only Alkaline battery.

## Dimension

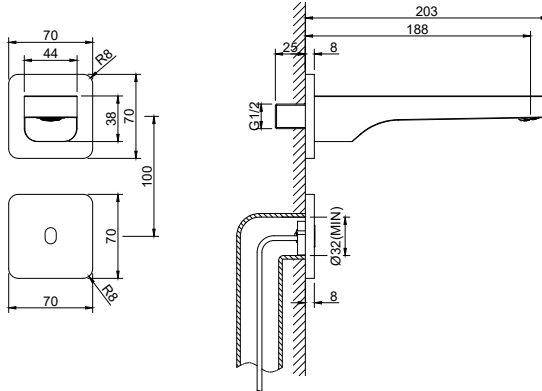

## Cleaning and care

Our Kitchen and bathroom products are made of the best materials to comply with the needs of the market with regard to design and functionality. To avoid damage to the product, it is necessary to take proper care of it.

Clean the products often with a soft cloth to keep it looking like new. For heavy cleaning you can use mild liquid detergents or non-abrasive liquid polisher. Rinse with water and dry with a soft cloth. Avoid abrasive cleaners, steel wool and harsh chemicals as these will dull the finish and void your warranty.